

**GROUP 600
ACCESSORIES
MOD. 600/71**

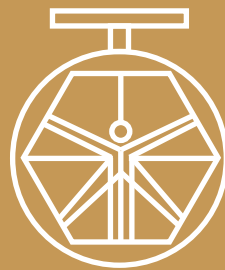

**DAVINCI
VALVES™**

**TECHNICAL
DATA SHEET
WATER Series**

SADDLES FOR PVC/PE PIPES

**DAVINCI
VALVES™**



**QUALITY
ASSUREMENT**

**DAVINCI
VALVES™**



**PRODUCT QT
ASSUREMENT**

**DAVINCI
VALVES™**



**COMPANY QT
ASSUREMENT**

www.davincivalves.com

18 Dongyu Street, Square One,
11th Floor 1101, Jinjiang District,
Chengdu, Sichuan CHINA

10F/Tower A, Billion Center,
1 Wang Kwong Road, Kowloon Bay
Kowloon HONG KONG

SADDLES FOR PVC/DI PIPES

Ref.603A / PN 10-16

APPLICATION:

Potable water, neutral liquids and sewage

WORKING CONDITIONS:

Working Temperature:

- 10 °C - + 120 °C. for EPDM

- 10 °C - + 82 °C. for NBR

GENERAL CHARACTERISTICS:

Range from DN50 to DN300

STANDARDS:

Comply with EN545

Pressure Test: EN 12266-1.

Body: 16 bar.

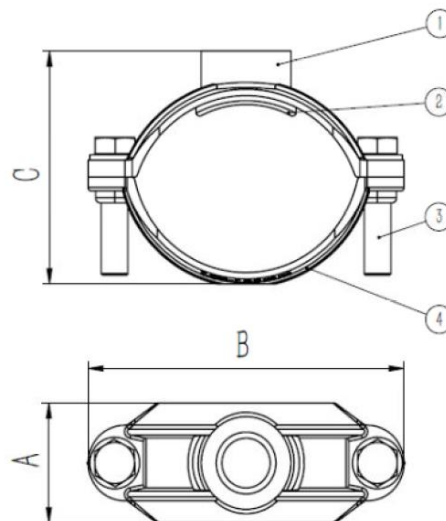

ITEM	DESCRIPTION	MATERIAL
1	UPPER BODY	GJS450-10
2	GASKET	EPDM
3	FASTENERS	CARBON STEEL 8.8 / A2
4	BOTTOM CLAMP	GJS450-10

All the components can be substituted with equivalent or higher-class materials.

DAVINCI VALVES LTD, is constantly looking at all ways of improving our products and services related to the water, fire and industry sector and therefore we reserve the right to change, without prior notice, any of the data contained here. Please contact our Technical Sales Department for detailed advice.
© 2018 DAVINCI VALVES LTD.

www.davincivalves.com info@davincivalves.com +34 616553797 / +86 17340168233
18 Dongyu Street, Square One 11th Floor 1101. Jinjiang District, Chengdu, Sichuan Province, China

SADDLES FOR PVC/DI PIPES

Ref.603A / PN 10-16

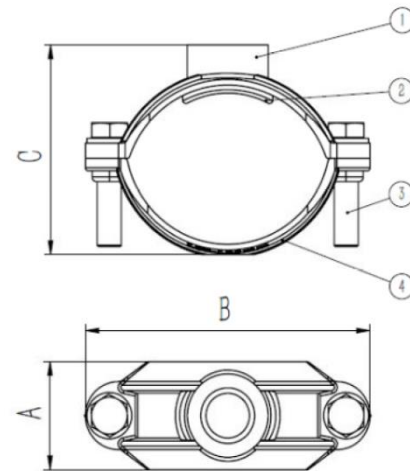
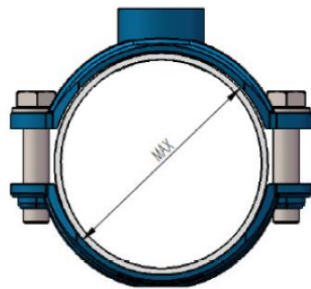
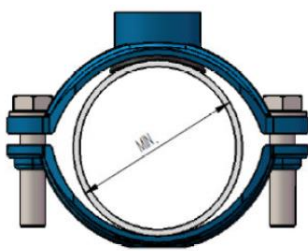

NOMINATE SIZE	TOLERANCE	OUTLET SIZE	BOLTS	A	B	C	APPOX WEIGHT
DN 40/1.5"	48-52	3/4"-1-1/4", M40*3	M12*40	70	120	120	0.78
DN50/2"	59-71	3/4"-1-1/4", M40*3	M12*50	70	135	135	0.93
		1-1/2"-2", M55*3		85			1.22
DN65/2.5"	69-88	3/4"-1-1/4", M40*3	M16*50	70	145	167	1.22
		1-1/2"-2", M55*3		85			1.40
DN80/3"	88-114	3/4"-1-1/4", M40*3	M16*70	70	165	178	1.38
		1-1/2"-2", M55*3		85			1.53
DN100/4"	107-135	3/4"-1-1/4", M40*3	M16*70	70	185	200	1.52
		1-1/2"-2", M55*3		85			1.67
DN125/5"	124-154	3/4"-1-1/4", M40*3	M16*70	70	210	225	1.85
		1-1/2"-2", M55*3		85			2.00
DN150/6"	158-184	3/4"-1-1/4", M40*3	M16*70	75	265	260	2.20
		1-1/2"-2", M55*3		85			2.40
DN200/8"	217-236	3/4"-1-1/4", M40*3	M16*70	75	315	320	2.85
		1-1/2"-2", M55*3		85			3.15
DN250/10"	272-300	3/4"-1-1/4", M40*3	M16*70	85	380	385	4.02
		1-1/2"-2", M55*3		95			4.35
DN300/12"	310-336	3/4"-1-1/4", M40*3	M16*70	85	415	420	4.56
		1-1/2"-2", M55*3		95			4.95

All the components can be substituted with equivalent or higher-class materials.

DAVINCI VALVES LTD, is constantly looking at all ways of improving our products and services related to the water, fire and industry sector and therefore we reserve the right to change, without prior notice, any of the data contained here. Please contact our Technical Sales Department for detailed advice.
© 2018 DAVINCI VALVES LTD.

www.davincivalves.com info@davincivalves.com +34 616553797 / +86 17340168233
18 Donqyu Street, Square One 11th Floor 1101. Jinjiang District, Chengdu, Sichuan Province, China

"For professionals who wants more"

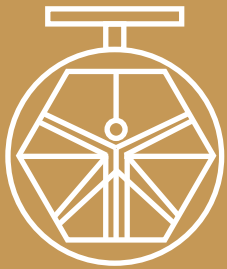

DAVINCI
VALVES™

www.davincivalves.com