

INDUSTRY
series

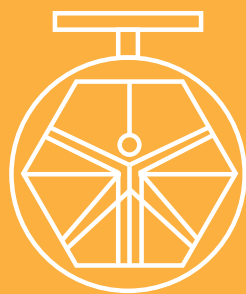

DAVINCI
VALVES™



CANNING



INDUSTRY

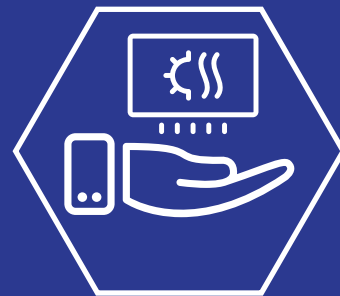

CLIMA

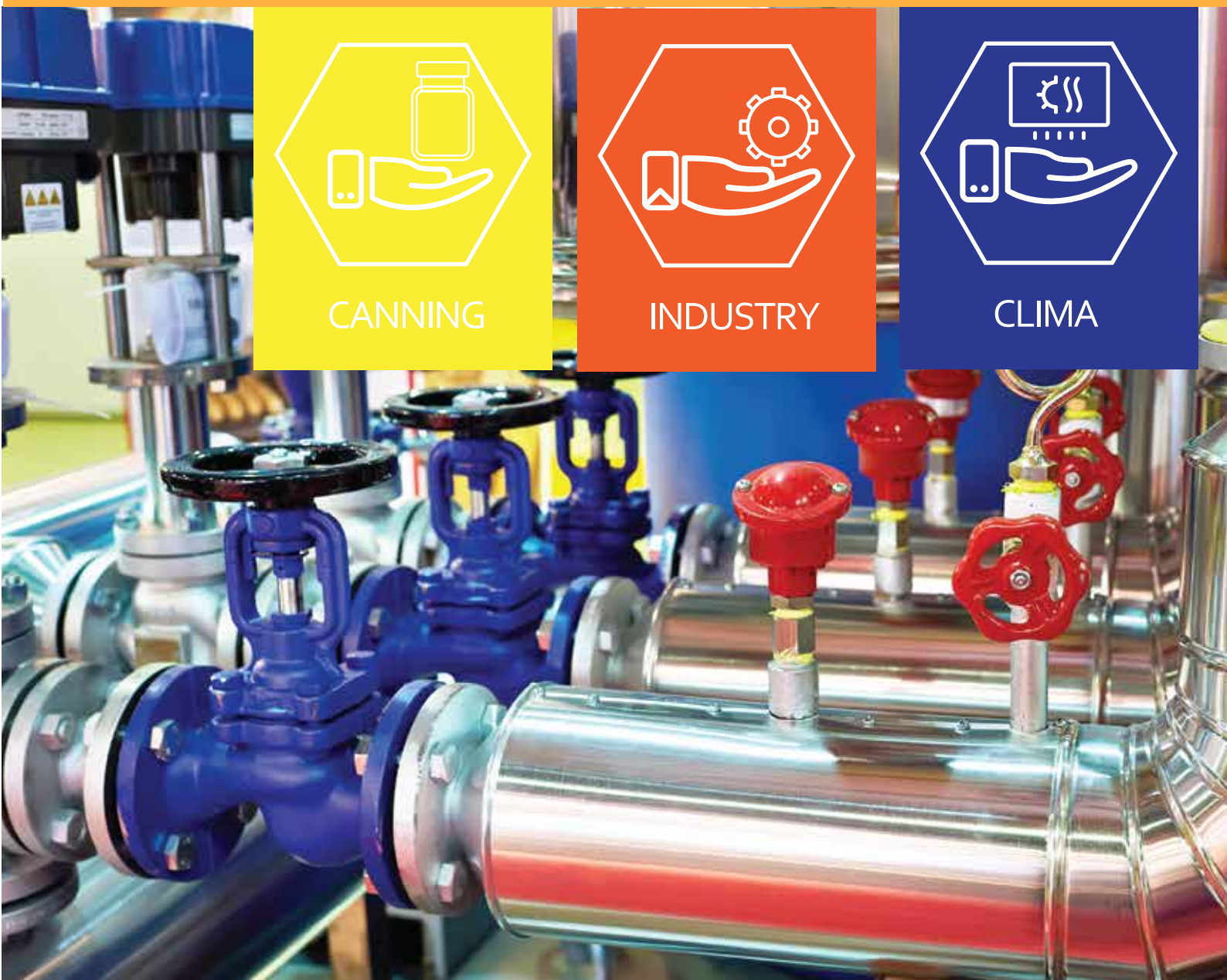

ENGLISH
VERSION

08/18-20

For professionals who wants more.

DAVINCI
VALVES™



QUALITY
ASSUREMENT

DAVINCI
VALVES™



PRODUCT QT
ASSUREMENT

DAVINCI
VALVES™



COMPANY QT
ASSUREMENT

INDUSTRY
VALVES
BROCHURE

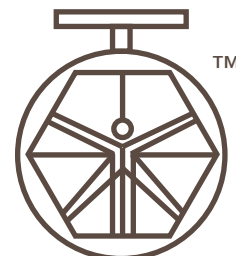

About DAVINCI VALVES

DAVINCI VALVES is a global leader in manufacture and trading services specialized in valves and pipe tubes complements.

The insights and quality services we deliver help build trust and confidence in the capital markets and in economies the world over. In so doing, we play a critical role in building a better working world for our people, for our clients and for our communities.

For more information about our organization, please visit davincivalves.com.

© 2018 DAVINCI VALVES. Trade Mark Registered. All Rights Reserved.

In line with DAVINCI VALVE's commitment to minimize its impact on the environment, this document has been printed on paper with a high recycled content.

This material has been prepared for general informational purposes only and is not intended to be relied other professional advice.

Always refer to the Technical Data Sheet for complete description of all listing criteria, design, parameters, installation instructions, and care and maintenance guidelines. The information given here is, to the best of our knowledge, correct at the time of going to press.

However our company, DAVINCI VALVES LTD, is constantly looking at all ways of improving our products and services related to the water, fire and industry sector and therefore we reserve the right to change, without prior notice, any of the data contained here.

Please contact our Technical Sales Department for detailed advice.

© 2018 DAVINCI VALVES LTD.



For professionals who wants more.

INDUSTRY
SERIES

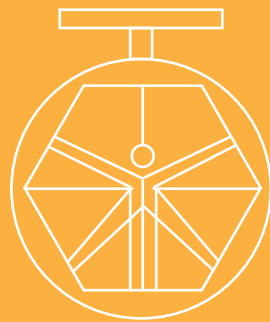

DAVINCI
VALVES™





DAVINCI
VALVES™

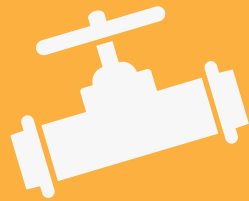

DAVINCI VALVES LTD dedicates all its development, production and marketing to the valves, hydrants and accessories for the supply of water, wastewater treatment, fire protection and industry applications all over the worldwide.

We assure to deliver the products we produce in high standard quality conditions with a strong technical feedback and that way ensure that our close customer relations reach the higher level of satisfaction.

We also offer the specific certification for the different types of tests that verify the measurements, the quantities, the weights, in addition to the tests that check both the components and the final product as the absolute guarantee delivery service of **DAVINCI VALVES LTD**.

Whichever requirements you may have, **DAVINCI VALVES LTD** as a worldwide solutions supplier have a wide range of standard products catalogue at your disposal and the capacity and expertise to manufacture of all kind of customised valves.



DAVINCI
VALVES™



INDUSTRY
series



DAVINCI
VALVES™



Ball Valves
Gate Valves
Complements
Accessories



CANNING



INDUSTRY



CLIMA

www.davincivalves.com
"Quality that satisfies"

INDUSTRY series

BALL VALVES

Gr. 140 - 143

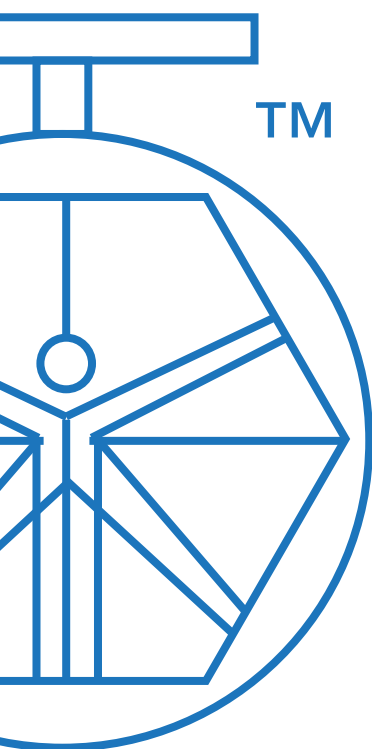

**1 PIECE BALL Ref. 140/41
DAVINCI VALVES
THREADED END**

Construction in S.steel 304/316/WCB
From ND-1/4" up to ND-4"
Working pressure NP-56/63
Threaded end DIN 259 / NPT
SW / BW



**2 PIECE BALL Ref. 141/42
DAVINCI VALVES
THREADED END**

Construction in S.steel 304/316/WCB
From ND-1/4" up to ND-4"
Working pressure NP-56/63
Threaded end DIN 259 / NPT
SW / BW



**3 PIECE BALL Ref. 142/43
DAVINCI VALVES
THREADED END**

Construction in S.steel 304/316/WCB
From ND-1/4" up to ND-4"
Working pressure NP-56/63
Threaded end DIN 259 / NPT
SW / BW



**2 PIECE BALL Ref. 143/44
DAVINCI VALVES
FLANGED END**

Construction in S.steel
304/316/WCB / Cast iron GG-25
Working pressure NP-16/25/40
Flanged ends NP-10/16 ANSI 150#

INDUSTRY
series

GATE
VALVES &
COMPLEMENTS

Gr. 140 - 2



CANNING



INDUSTRY



CLIMA



GATE VALVE CF8M Ref. 200A/12
DAVINCI VALVES
FLANGED END NON RISING STEM

Construction in S.steel 304/316/WCB
From ND-1/4" up to ND-4"
Working pressure NP-56/63
Threaded end DIN 259 / NPT
SW / BW



Y STRAINERS Ref. 320/62
STAINLESS STEEL
FLANGED END

Material construction S.steel 316
Screen S.steel 316
Working pressure 1.0Mpa 1.6Mpa
Face to face according to
DIN 3202 F1

"For professionals..."



"...who wants more"



DAVINCI
VALVES™

INDUSTRY series

GLOBE VALVES

Gr. 140 - 2

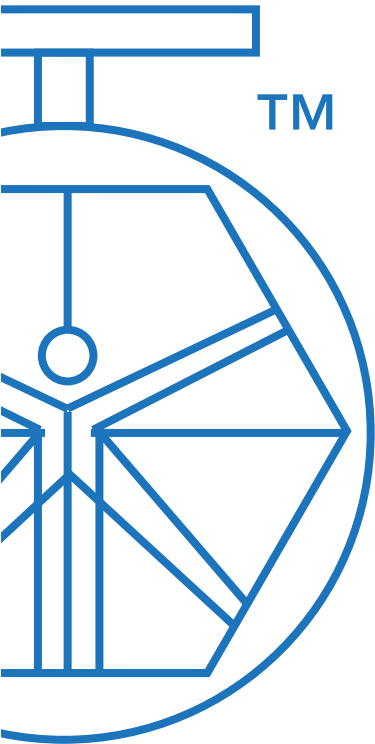

GLOBE Ref. 150/45
DAVINCI VALVES
FLANGED END

Material construction in
Ductile iron GJS450
Working pressure 1.0Mpa 1.6Mpa
Epoxy paint FBE Min 250 Mic



GLOBE Ref. 150/47
DAVINCI VALVES
STAINLESS STEEL FLANGED END

Material construction in
Stainless Steel CF8M
Working pressure 1.0Mpa 1.6Mpa
Epoxy paint FBE Min 250 Mic

"For professionals..."



"...who gets more"



DAVINCI
VALVES™

INDUSTRY *series*

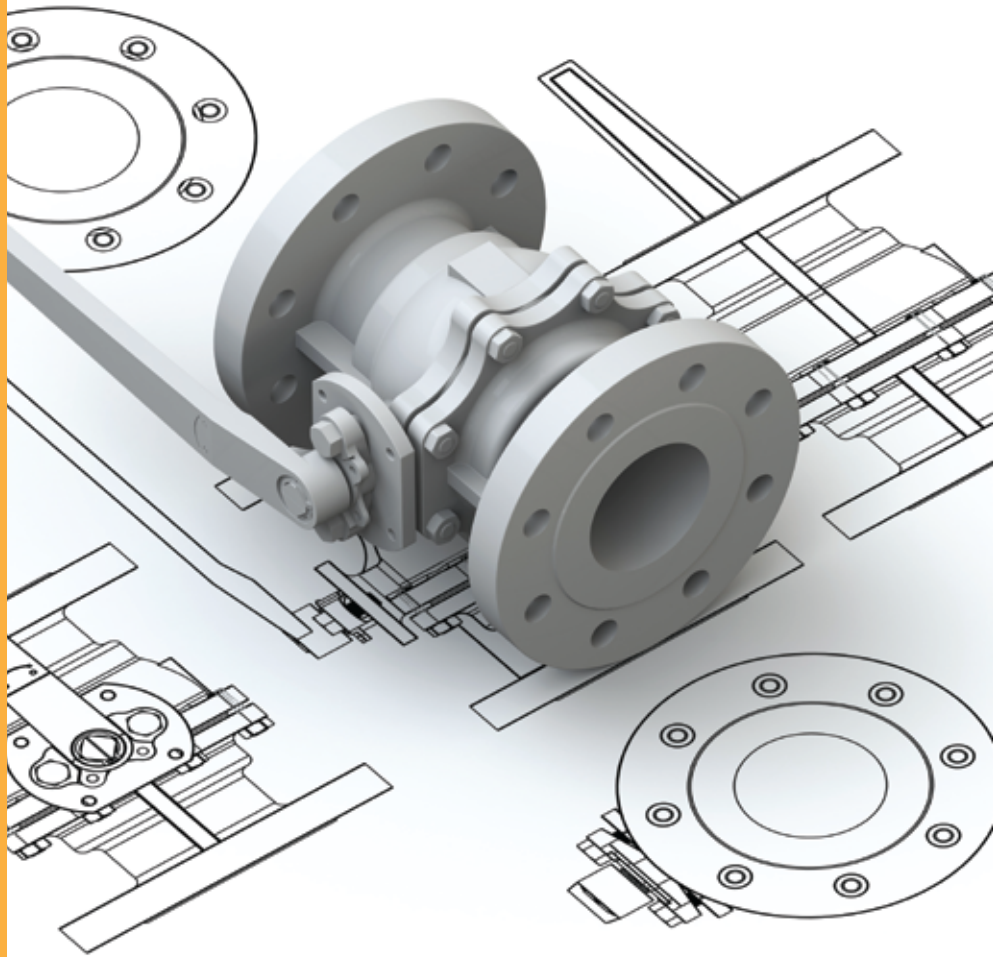
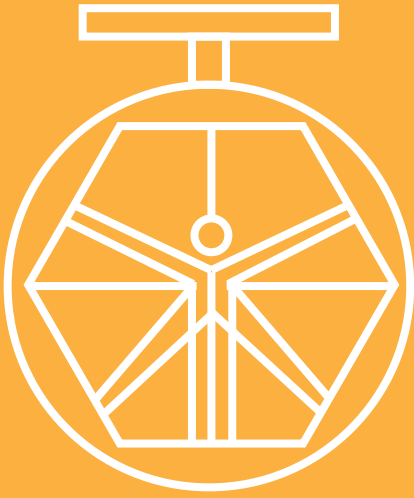

Controlling fluids like oil or other corrosive fluids in aggressive media can be a tuff thing if you may not count with quality products which fits perfectly for that purpose.

In **DAVINCI VALVES LTD** we look after the very best control and management of all kind of fluids and due to our customer requirements in canning or paper industries, such as from climatization and some specific chemical projects we have developed valves industry product program where you may count with ball valves, gate valves and aditional complements and accesories to develop the specific installation as per your needs.



"For professionals who wants more"

DAVINCI VALVES LTD IS THE
GLOBAL VALVE MANUFACTURE LEADER
IN FOLLOWING SEGMENTS:



Water Series

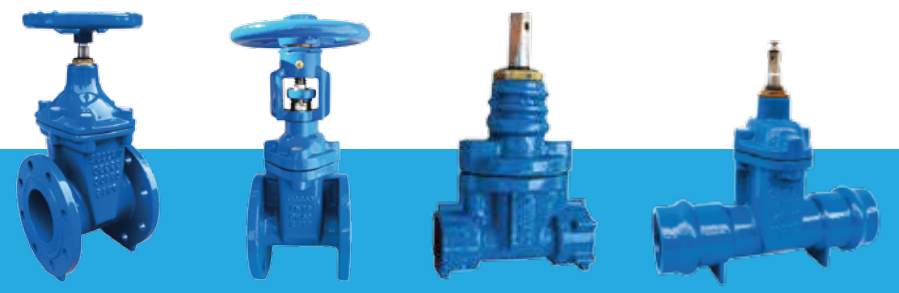

Fire Series



Industry Series



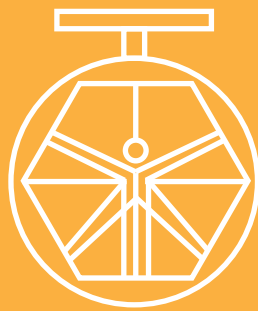

DAVINCI
VALVES™

"Quality that satisfies"

Main Offices: HONG KONG CHINA SPAIN

Phone CHINA: 0086.173.401.68.233

Phone SPAIN: 0034.616.553.797

davinci@davincivalves.com

davincivalves.com